



7 INCH
MIRROR MONITOR SYSTEM
Clip-on
Part # SMM07



Est. 2002 with over 18+ years of the
Latest Engineering, Highest Quality, Best Support
COST EFFICIENT

a division of
Component Solution Services
56600 Twin Branch Dr.,
Mishawaka, IN 46545
574-807-6002



TABLE OF CONTENTS & PHONE NUMBERS

Contents

<i>TABLE OF CONTENTS & PHONE NUMBERS</i>	2
<i>ABOUT US</i>	3
<i>THINK SAFETY</i>	4
<i>SYSTEM FEATURES</i>	6
<i>SYSTEM MEASUREMENTS</i>	7
<i>SYSTEM COMPONENTS</i>	8
<i>SYSTEM COMPONENTS</i>	9
<i>CABLE CONNECTIONS</i>	10
<i>MONITOR OPERATIONS</i>	11
<i>SMM07 OPTIONS</i>	13
<i>OEM AND FLEET OPTIONS</i>	14
<i>LIMITED ONE (1) YEAR WARRANTY</i>	15
<i>TECHNICAL SUPPORT</i>	16

SALES
574-807-6005

TECH SUPPORT
574-807-6004

Our tech support is manned by real people in front of all of our powered-up systems prepared to knowledgeably talk you through an issue solution – not a person with no knowledge in front of a spreadsheet of prepared phrases. Verity=24/7 support for OEMs and Fleets.

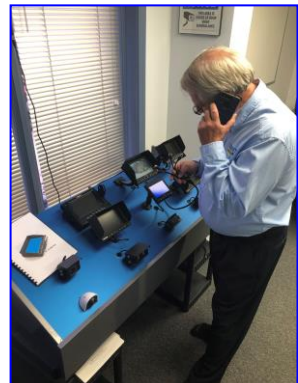

ABOUT US

Component Solution Services, LLC offers the Verity Rear Vision Systems[®] (Verity) to meet any requirements and price point within the trucking, specialty vehicles, and RV industry. Verity is also home to the Supreme View[®] line of specialty format systems. Our standard cabled systems offer unparalleled features into the trucking and RV industries. Designed for professional drivers, **Verity** develops and markets products and applications to transmit video, audio, and data either individually or in all combinations. The company has also developed, manufactured, and marketed different kinds of personal and vehicle video cameras, DVRs, and accessories for the commercial transportation, fire/rescue, and marine OEM markets.



The photograph above shows our 2020 warehouse addition of 5,000 ft.

Use this barcode or
link to visit our
website
www.verityrvs.com



THINK SAFETY

Read our manual before operating
or installing this system.

Most likely, your system came pre-installed so the installation section would be for reference.

Thank you for your purchase of our Verity Rear Vision System SMM07. When installed and used properly, your SMM07 is designed to deliver you years of trouble-free operation. This manual contains important information required to properly install and operate the unit. Verity units are designed for quick installation by trained professionals in proper installation environments. Our designs are based on decades of working with vehicle manufacturers.

Verity products are intended to be installed as a supplement and our observation systems and/or products are not intended for use as substitutes for rear-view mirror devices, or for any other standard motor vehicle equipment which may be required to be installed on vehicles by law. Verity products promote improving the vehicle operator's field of view. Our products are no substitute for proper defensive driving techniques, observance of traffic laws, and motor vehicle safety regulations.

Installation Location

It is unlawful in most locals for any person to drive a motor vehicle equipped with a television viewer/screen located at any point forward of the back of the driver's seat (or in any location that is visible, directly or indirectly) to the driver while operating the vehicle. Our systems are designed to be used primarily as a rear observation device.

DO NOT OPEN ANY COMPONENT. There are no serviceable parts inside any of the components of the SMM07. Opening the product will break the tamper indicators and void the warranty. Contact our tech support if a problem should arise: 574-807-6002. For faster response, fill out a service ticket found on our website. www.verityrvs.com

WARNING

- ◆ Do not place heavy objects on cables or cover them with carpet or mats.
- ◆ Do not place cables where they can be crushed in any manner.
- ◆ Our systems are designed as a driving aid. Watching videos, broadcasts, DVDs and/or any images other than intended driving assistance cameras is prohibited.

CAUTION

- ◆ To avoid damage to the electronic circuit, stop using this product while doing welding work to the vehicle and/or trailers.
- ◆ Never immerse any component in water, and do not employ spray cleaners. When cleaning, use a damp lint-free cloth only.
- ◆ Connect this unit only to other compatible devices.
- ◆ Although our products have built-in surge and cross polarity protection, make sure all cables are connected properly; improper cable connections may damage the camera and the monitor.
- ◆ Cables should not be allowed to touch hot or rotating parts, such as the engine, ventilator, etc.
- ◆ Do not locate the monitor near heat generating vents or devices.
- ◆ Turn off power to the monitor when connecting the camera.

Monitors are not designed to be waterproof. (Our SM07F waterproof monitor is the exception).

Exposure to water, such as rain, may damage the unit.

SYSTEM FEATURES

MONITOR SPECIFICATIONS

(Monitor part #MMK07)

7-inch Clip-On mirror monitor

TFT-LCD (16:9)

Format: NTSC

New Higher Resolution: 800 (W) x 480(H) RGB

Power supply: DC 12V

Video: 2-channel video input, V1/V1 switching with 4-pin male aviation plugs

Contrast: 300:1

Waterproof fuses

CAMERA SPECIFICATIONS

(Camera Part #C001S)

Horizontal Resolution: 600 TV Lines

TV System: NTSC

Image Type: 1/3 Inch Color CCD Sharp® (or equivalent)
(no cheap off brands used)

Effective Pixel: 510 x 492

Illumination: 0 Lux (built-in 17 high output IR LEDs for night vision)

Aluminum Housing

Waterproof: IP69K

Power Supply: DC 12V (power from the monitor)

Shockproof: 10G

Operating Temperature: -40°~70°C

Built-in Microphone

Viewing Angle: 170°



SYSTEM MEASUREMENTS

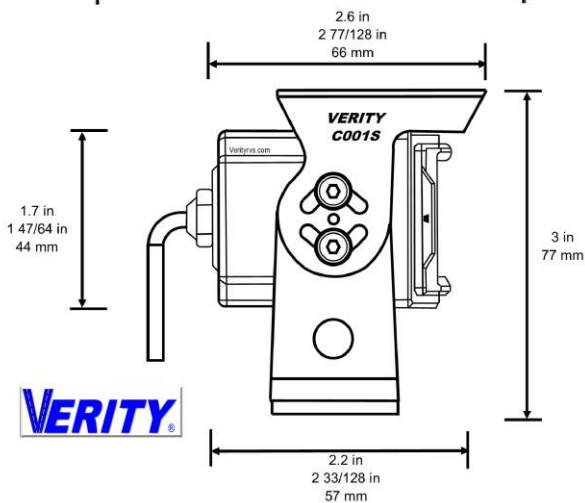
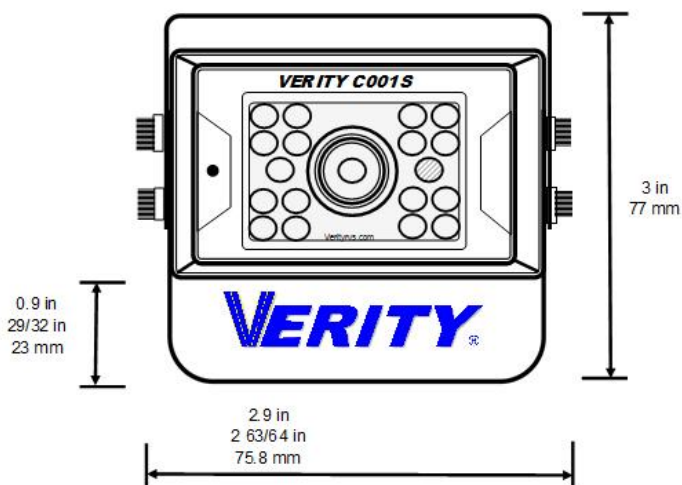
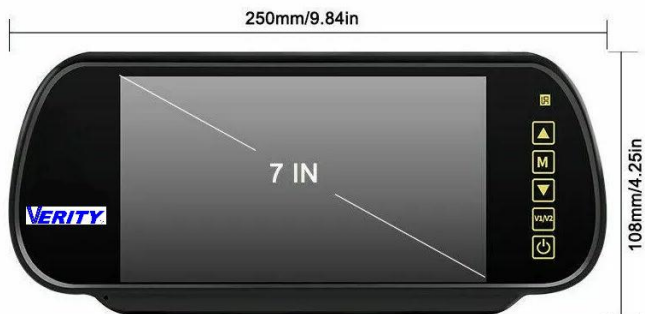

SYSTEM COMPONENTS



7" Clip-on / post
Mirror Monitor



Manual



Monitor Harness w/
waterproof fuse



Windshield Bracket
Post mount



20-Meter Camera



Weatherproof Camera
with night vision



Hardware



Remote

SYSTEM COMPONENTS

This monitor can be mounted over any existing mirror.
Take caution not to block any sensors on the current mirror.



Camera Connection

Do NOT make the cable tight from the back of camera going into the truck – form a drip loop with slack.

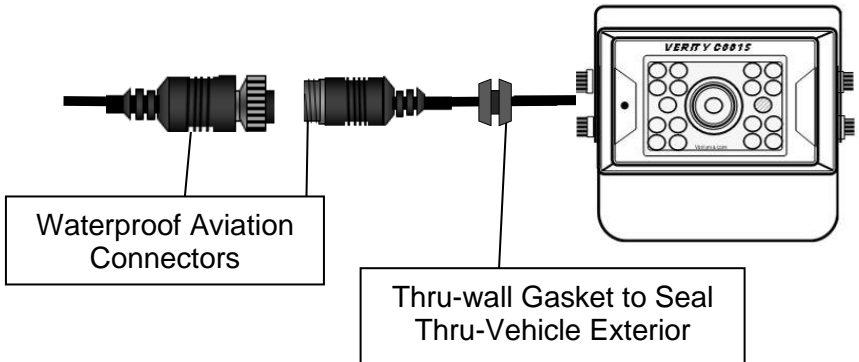

Be sure to use the vibration gasket when installing the camera. It is packaged with the camera hex wrench.

CABLE CONNECTIONS



Verity Rear Vision Systems Wire Connection Key
4-pin camera connectors & trigger wires

Camera 2 (Green trigger wire

Red wire to key-on hot (+) 12-32v. DC (fused)

Black wire to GND. (-)

Green wire to positive back-up light

BE SURE TO ALIGN MONITOR CABLE CONNECTION

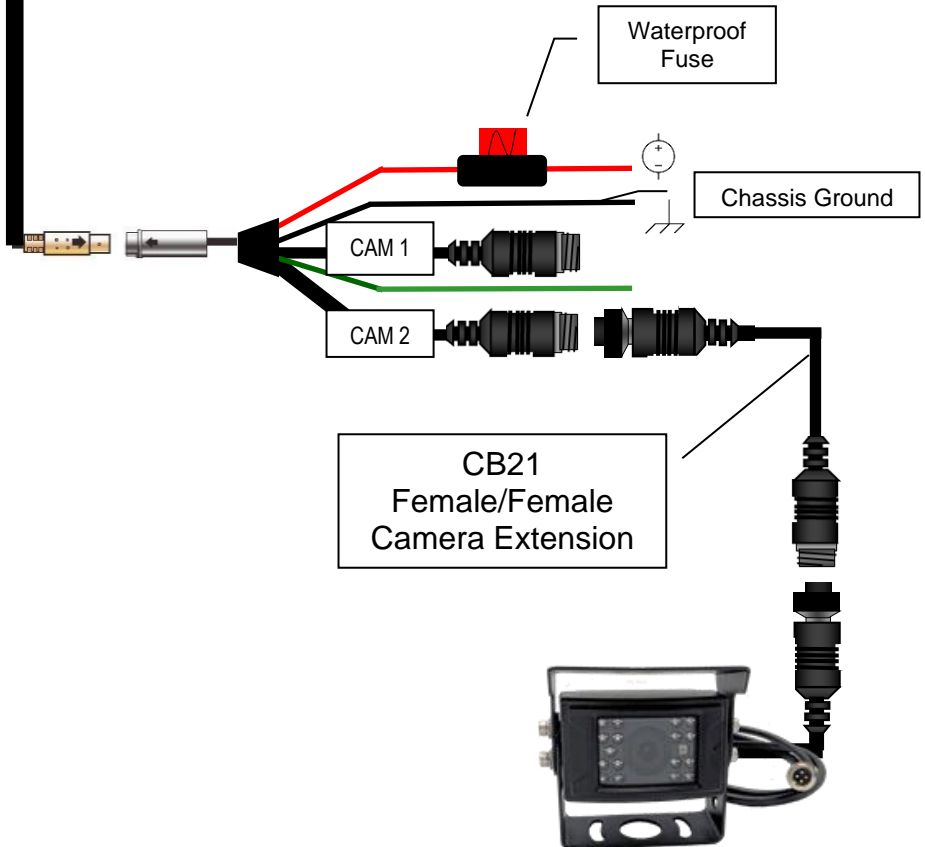

MONITOR OPERATIONS

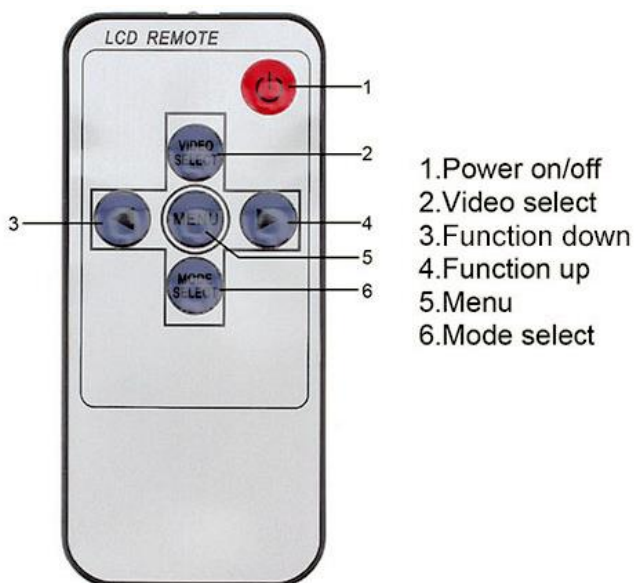
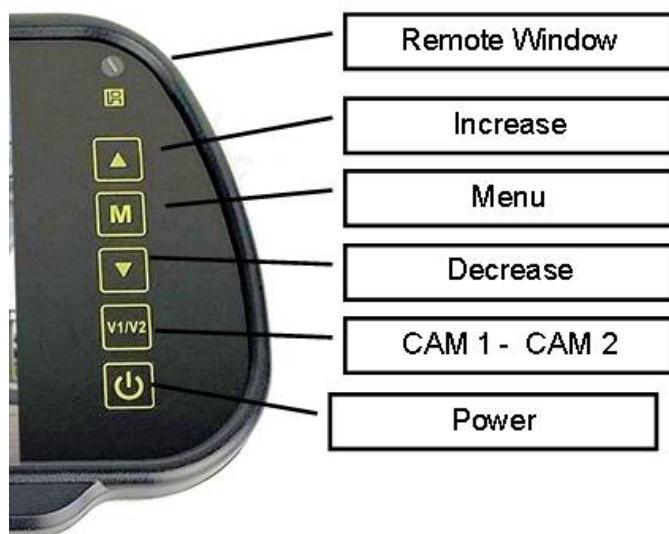

Menu

BRIGHTNESS



Use DOWN / UP arrows to adjust the brightness

CONTRAST



Use DOWN / UP arrows to adjust contrast

COLOR



Use DOWN / UP arrows to adjust the color

Language There are 12 to choose from

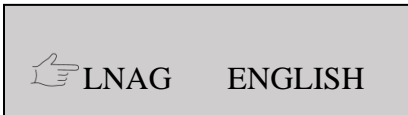

Use DOWN / UP arrows to change the language

ZOOM

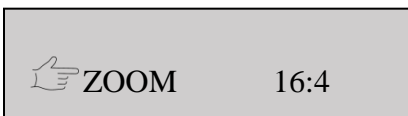

Use DOWN / UP arrows to adjust zoom 16:4 / 4:3 (zoom in)

ROTATE



Use DOWN / UP arrows to Rotation / Flip



RESET

Restores all preset factory settings

SMM07 OPTIONS

C100ZV Camera Cover

C115 Side Camera



OEM AND FLEET OPTIONS



In-bumper Cameras



License plate / wall mount Cameras



Low-Profile Cameras

Exceed FMVS111 Cameras



Verity Rear Vision Systems
A division of
COMPONENT SOLUTION SERVICES (CSS)
LIMITED ONE (1) YEAR WARRANTY

1. VerityRVS® products' warranties are not transferable. The warranties apply to the retail consumer for one (1) year and covers against defects in material and quality. Cables are not warrantied.

2. Defective components will be replaced or repaired, based on a VerityRVS evaluation of the component. In-bound shipping charges, based on the VerityRVS rate allocated in the RMA (returned merchandise agreement), will be covered once the component has been deemed defective at the CSS warranty facility. The pre-assigned in-bound freight will be supplied upon the return of the product. All repaired/replaced warranty parts shall be for the remaining duration of the original warranty time period.

3. VerityRVS takes pride in our products and will aid in the processing of your components:
 - a) All warranty claimants must have consulted our technical support department for troubleshooting and the acquiring of an RMA. Contact can be made via email at techsupport@verityrvs.com or call 574-807-6002.
 - b) When the warranty claim is made, the consumer must establish the warranty start dates by presenting documentation regarding the date of retail purchase (e.g., bill of sale).
 - c) Service performed by non-authorized service personnel may void all warranty claims.
 - d) VerityRVS will make no payments for system removal or system re-installing, mileage allowance, or transportation expenses.The limited warranty does not cover damage resulting from misuse, accident, modification, or alteration to hardware or software, tampering, unsuitable physical or operating environment beyond product specifications, improper maintenance, or failure caused by a product for which VerityRVS is not responsible. There is no warranty for any product with removed or altered identification labels. VerityRVS DOES NOT PROVIDE ANY OTHER WARRANTIES OF ANY KIND, INCLUDING, BUT NOT LIMITED TO, THE IMPLIED WARRANTIES OR CONDITIONS OF MERCHANTABILITY AND FITNESS FOR A PARTICULAR PURPOSE. SOME JURISDICTIONS DO NOT ALLOW THE LIMITATION OF IMPLIED WARRANTIES, SO THIS LIMITATION MAY NOT APPLY TO YOU.

4. This warranty gives you specific legal rights, and you may also have other rights that vary from state to state.

TECHNICAL SUPPORT

A service ticket can be found online and completed to supply the quickest service. The service ticket can be easily found on our web site www.VerityRVS.com or use the 3-D code below. Please have the serial number of the system, which is found on the back of the monitor when contacting the service department. We take great pride in delivering the most dependable product in the industry. Each item was 100% QC tested, and then we randomly recheck another up to 10% before it leaves our hands to you. We have a .024% issue rate for all Verity cameras and monitors over the past eight years.

Email Tech Support: tech@verityrvs.com

Phone Tech Support: 574-807-6004

Note: After office hours calls will be answered or called back as quickly as possible by one of our Tech Team. Please note: Technicians cannot provide pricing or availability.



a division of

Component Solution Services

56600 Twin Branch Dr.,

Mishawaka, IN 46545

574-807-6002

Toll-Free 844-875-4799

We at Verity Rear Vision Systems would like to personally thank you for purchasing our product. We at Verity strive to supply the best products at a competitive price. We care that you enjoy a safe driving experience.